

# Development of DSTATCOM Optimal Sizing and Location Technique Based on IA-GA for Power Loss Reduction and Voltage Profile Enhancement in an RDN

Mohamed Amidu Kallon<sup>1</sup> , George Nyauma Nyakoe<sup>2</sup>  and Christopher Maina Muriithi<sup>3</sup>

<sup>1</sup>Student, Pan African University Institute for Basic Sciences Technology and Innovation, Nairobi, Kenya, [kallon.mohamed@students.jkuat.ac.ke](mailto:kallon.mohamed@students.jkuat.ac.ke)

<sup>2</sup>Associate Professor, Electrical Engineering, Jomo Kenyatta University of Agriculture and Technology, Nairobi, Kenya [nyakoe@eng.jkuat.ac.ke](mailto:nyakoe@eng.jkuat.ac.ke)

<sup>3</sup>Associate Professor, School of Engineering and Technology, Muranga University of Technology, Kenya [cmmuriithi@mut.ac.ke](mailto:cmmuriithi@mut.ac.ke)

\*Correspondence: Mohamed Amidu Kallon; Email: [kallon.mohamed@students.jkuat.ac.ke](mailto:kallon.mohamed@students.jkuat.ac.ke); Tel.: +254-759-579-075

**ABSTRACT:** The efficiency of electrical distribution systems is being more affected by the increase in voltage drops and power losses. These issues of voltage drop and power loss can be significantly minimized by the incorporation of a Distribution Static Compensator (DSTATCOM) in the distribution network. However, inappropriate positioning and sizing of DSTATCOM can undermine its efficiency. Despite the contributions of many researchers to the optimal placement of DSTATCOM and other compensators in distribution networks, the problems of voltage drop, power losses, and power quality persist, necessitating the need for additional research in this area. In this paper, an innovative technique based on hybridized Immune and Genetic Algorithm (IA-GA) for optimal DSTATCOM placement and sizing for three distinct load levels is proposed. Simulation and analysis of the proposed algorithm were carried out using IEEE-33 bus radial distribution network (RDN) in MATLAB. The simulation results demonstrate a substantial decrease in power loss and a significant improvement in the voltage profile. Evaluation of the proposed method against existing techniques reveals that the proposed technique outperforms IA and PSO in terms of decreasing power loss and enhancement of voltage profiles. A cost-benefit analysis was performed, and it was discovered that the proposed technique yields improved annual cost savings.

**Keywords:** DSTATCOM, hybrid IA-GA, IEEE-33 bus, power loss reduction, radial distribution network, voltage profile improvement.

## ARTICLE INFORMATION

**Author(s):** Mohamed Amidu Kallon, George Nyauma Nyakoe and Christopher Maina Muriithi

**Received:** Nov 21, 2021; **Accepted:** Jan 05, 2022; **Published:** Jan 30, 2022;

**e-ISSN:** 2347-470X;

**Paper Id:** IJEER-090407;

**Citation:** [doi.org/10.37391/IJEER.090402](https://doi.org/10.37391/IJEER.090402)

**Webpage-link:**

<https://ijeer.forexjournal.co.in/archive/volume-9/ijeer-090402.html>



DSTATCOM is a distribution FACTS (DFACTS) device that is shunt connected for reactive power compensation. In recent years, DSTATCOM has been utilized to improve the adaptability and control of power system operations, such as managing reactive power flow, power quality enhancement, power loss mitigation, and current and voltage regulation [2].

The contribution of DSTATCOM in mitigating power losses and improvement of voltage profile is primarily acquired by its location and size, network architecture and layout, and its configuration [3].

Many optimization techniques have been used in recent decades to optimize the installation of DSTATCOM to minimize overall power losses, including deterministic approaches, classical metaheuristic techniques, and also hybrid metaheuristic strategies [4]. Considering the high technical losses in distribution networks, DSTATCOM or other forms of compensators should be mounted in distribution networks at appropriate locations and in proper sizes to reduce the reactive currents flowing in the branches or to inject/absorb reactive power as when necessary in order to boost voltages and mitigate overall power losses. Distribution network power loss is estimated to account for about 13% of overall generated power in power systems [5],[6] and can be minimized by incorporating compensators into the distribution network to minimize reactive power flows. Furthermore, by lowering

## 1. INTRODUCTION

The growing power demand, high costs associated with building new grids, and environmental concerns have created unavoidable challenges such as power line overload and excessive power transmission, voltage instability, high losses, low power quality, voltage profile problems, and reliability issues. FACTS (Flexible Alternating Current Transmission Systems) devices have shown to be successful and feasible in minimizing the aforementioned transmission and distribution system problems. However, in order to realize the benefits of FACTS devices, their placement and capacity should be optimized. Therefore, the FACTS allocation problem, which involves determining the optimal size and positioning of FACTS and custom controllers in power systems, has piqued the interest of numerous researchers [1].

branch currents, voltage drops can be reduced. In particular, the number of compensators deployed, as well as the position and capacity of each compensator are critical concerns in developing and running distribution networks [7].

The decline of voltages at load terminals are among the most popular power quality issues today [8]. A voltage drop happens whenever the operating voltage falls below its real rating due to the load's excessive reactive power consumption [9]. Voltage drops can impact the operation of sensitive loads as well as lowering system efficiency. The voltage drop is by default a three-phase effect in three-phase networks, affecting both phase to phase and phase to ground voltages. A disturbance in the utility grid, a fault inside the premises of the customer, or a significant rise in the load current, such as a transformer energizing or starting a motor, may both induce a voltage drop.

Voltage drop and power loss problems have been and are still a critical concern in distribution networks and have resulted in much loss of revenue and properties on both the utility and the consumers [10], [11]. In order to alleviate these problems, numerous researches have been conducted by various researchers on the optimal application of FACTS devices, such as DSTATCOM, and other compensators [12], [13]. In [14], Taher and Afsari adopted IA (immune algorithm) to obtain DSTATCOM's best position and size in distribution systems in order to minimize energy cost loss, power congestion, and boost the voltage profile. For both the test systems used, IA has lower objective function values than GA at all load levels. Despite outperforming GA, IA has a premature convergence problem which results in low power loss reduction and minimal voltage improvement.

Tejaswini and Susitra [15] suggested a hybrid Whale and Grey Wolf optimization technique to locate and size DSTATCOM in an RDN optimally. The method was designed to improve power quality in an RDN by placing DSTATCOM on a node that is prone to voltage collapse. The suggested approach's performance was compared to that of existing metaheuristics, but the cost analysis revealed that it is not cost-effective. Similarly, HS (harmony search) algorithm, which is inspired by the improvisation method in music, was used to find the best position and optimal size for DSTATCOM with the objective function of minimizing copper losses [6]. On an IEEE 33-bus delivery network, the proposed approach was tested. The suggested HS outperforms IA in loss minimization, according to the findings, but only normal load condition was considered in this study.

Khan et al [16] proposed an improved bacterial foraging search algorithm (IBFA) to optimally locate and size DSTATCOM in a distribution network. The study's objective was to reduce power loss while also enhancing voltage stability and profile. When compared, IBFA outperformed conventional BFA. However, no additional metaheuristic was utilized in the comparison other than BFA, making it difficult to evaluate the performance of the suggested technique. The authors of [17] proposed an approach that is fuzzy-GA based

for distribution network feeder reconfiguration using DSTATCOM with the aim of reducing actual power loss and running costs. The fuzzy membership functions of loss sensitivity were used in the proposed solution for selecting weak nodes within the distribution power network for the proper positioning of DSTATCOM, and a GA was used to monitor the optimal parameter adjustments of the DSTATCOM unit as well as the selection of optimal tie switches in the reconfiguration process. However, few membership functions were used for loss sensitivity which compromises the selection of weaker nodes and hence the DSTATCOM placement. Rukmani et al [18] proposed a novel bio-inspired Cuckoo Search Algorithm (CSA) to optimally locate and size DSTATCOM in an RDN. The optimal site was determined by utilizing the loss sensitivity factor (LSF). The objective function was aimed to reduce overall power loss and improve the voltage profile. In the simulation, an IEEE 33-bus RDN was employed to validate the approach's efficacy. The comparative results, however, demonstrate a little reduction in power loss and a slight improvement in the voltage profile after DSTATCOM placement. Other algorithms such as PSO, binary gravitational search algorithm (BGS), hybrid BF-GWO, ANN, Improved Cat Swarm Optimization (ICSO), SLFA, Penguin Optimization Search Algorithm (PSOA), modified SCA, Ant Colony Optimization (ACO), and Bat Algorithm (BA), have also been used in [19]–[27] to optimally allocate DSTATCOM to reduce power loss and enhance voltage profile.

In this paper, using MATLAB, a hybrid of Immune Algorithm (IA) and Genetic Algorithm (GA) is proposed to develop an algorithm that uses the data of a radial IEEE-33 bus distribution system to obtain the optimal DSTATCOM location and size. The algorithm then optimally allocates the sized DSTATCOM to the distribution network for power loss mitigation and voltage profile improvement. The purpose of hybridizing IA and GA is to solve the premature convergence problem faced by IA and to enhance its performance.

*The remainder of the paper is organized as follows:* The problem formulation is presented in *Section 2*, which primarily includes the objective function, constraints, and total cost saving formulation. *Section 3* describes the DSTATCOM and RDN system modelling, as well as the forward and backward sweep load flow and DSTATCOM incorporation. *Section 4* presents the proposed approach's step-by-step procedures, while *Section 5* contains the simulation results and discussion, cost-benefit analysis, and comparison and performance analysis of the proposed approach. The study's conclusion is presented in *Section 6*.

## 2. PROBLEM FORMULATION

Optimal DSTATCOM positioning and sizing can result in less power losses and an enhancement in distribution network voltage profiles. In this study, the optimal DSTATCOM position and size in an IEEE-33 bus RDN is obtained using the hybridization of immune and genetic algorithms (IA-GA) for three load scenarios (light, medium and peak load conditions). The formulation of the

problem is based on an objective function and the constraints detailed below:

## 2.1 Objective Function

In this study, the optimal placement and reactive power of DSTATCOM in an RDN (IEEE 33 bus) are determined in a steady-state condition. The objective function, OF, considers minimizing the power loss and the DSTATCOM size in the distribution network. The current and voltage constraints are expressed in the objective function as penalty factors. The objective function also entails the cost of the energy lost, the yearly duration of each load level, the time proportion of each load level, and the yearly DSTATCOM cost of investment. The various components of the objective function are described below:

### 2.1.1 Power Loss and Time Duration Proportion

The power losses in  $i^{\text{th}}$  load level can be described as [28];

$$P_{l_i} = \sum_{j=1}^{nl} R_j |I_j|^2 \quad (1)$$

where  $P_{l_i}$  indicates the power losses in the  $i^{\text{th}}$  load level, shows the resistance of the  $j^{\text{th}}$  line,  $nl$  signifies the current magnitude flowing in the  $j^{\text{th}}$  line, and represents the number of lines.  $i = 1, 2, \text{ and } 3$ . Where 1 represents light load, 2 represents medium load, and 3 signifies peak load. The following equation was used to determine the proportion of the individual ( $i^{\text{th}}$ ) load level time and the total time duration for the three load levels [29]:

$$K_{ci} = \frac{T_i}{\sum_{i=1}^3 T_i} \quad (2)$$

Where  $K_{ci}$  is the time proportion of the  $i^{\text{th}}$  load level and  $T_i$  is the time of the individual load level.

### 2.1.2 Investment Cost

The projected income and investment expenses must be compared across the whole planning horizon to determine the economic worth of the DSTATCOM installation plan. By applying the present worth factor principle, the cost of DSTATCOM investment can be obtained from Equation (3) [30]–[33].

$$D_{\text{cost}} = D_{\text{cost}_i} * \frac{(1+r)^{n_D} * r}{(1+r)^{n_D} - 1} \quad (3)$$

where  $D_{\text{cost}}$  is the annual investment cost of the DSTATCOM in the load level,  $D_{\text{cost}_i}$  is  $i^{\text{th}}$  load level cost of investment in the year of allocation,  $n_D$  is the DSTATCOM's longevity, and denotes the rate of return.

### 2.1.3 Penalty Factor

When the operational variables such as line currents and bus voltages exceed the required safe limits, a penalty factor is applied. The constraints are determined in a steady-state situation. Equation (4) presents the penalty factor (PF) utilized in the suggested objective function.

$$PF = \prod_{i=1}^3 \left( \prod_{j=1}^{nl} I_{\text{ovr}} \prod_{j=1}^{nb} V_{\text{ovr}} \right) \quad (4)$$

Where  $nb$  and  $nl$  indicate the number of buses and number of lines respectively.  $I_{\text{ovr}}$  and  $V_{\text{ovr}}$  are respectively the overcurrent and overvoltage. The  $I_{\text{ovr}}$  and  $V_{\text{ovr}}$  constraints are given in Equations (5) and (6).

$$I_{\text{ovr}} = \begin{cases} 1 & \text{if } I_j \leq I_{\text{max}} \\ \exp\left(\lambda \left|1 - \frac{I_j}{I_{\text{max}}}\right|\right) & \text{if } I_j > I_{\text{max}} \end{cases} \quad (5)$$

$$V_{\text{ovr}} = \begin{cases} 1 & \text{if } V_{\text{min}} \leq V_r \leq V_{\text{max}} \\ \exp(\mu |1 - V_r|) & \text{otherwise} \end{cases} \quad (6)$$

where  $I_{\text{max}}$  denotes the maximum current that flows in the network line,  $\mu$  and  $\lambda$  are small constants,  $V_r$  is the  $r^{\text{th}}$  bus voltage in p.u, and  $V_{\text{min}}$  and  $V_{\text{max}}$  are the minimum and maximum voltage constraints, respectively.

### 2.1.4 General Objective Function

By combining Equations (1) to (4), the expression for the objective function (OF) of the proposed three load levels is given by;

$$OF = \left[ K_e \sum_{i=1}^3 (T_i P_{l_i}) + \sum_{i=1}^3 (K_{ci} D_{\text{cost}}) \right] [PF] \quad (7)$$

Where  $i$  indicates the number of load levels,  $K_e$  is the cost of energy, and PF is the penalty factor of Equation (4).

The first term in the right-hand side of Equation (7) denotes the total cost of energy loss and DSTATCOM installations while the second term signifies the penalty factor (voltage and current constraints of the network, and serves as a penalty factor when the voltage or current boundaries deviate).

## 2.2 Constraints

### 2.2.1 Current Constraint

The current that flows through each branch should not exceed the maximum current tolerance of the conductor as given in Equation (8).

$$I_{b(j)} \leq I_{b(j)}^{\text{max}} \quad (8)$$

Where  $I_{b(j)}$  denotes the current magnitude that flows through branch  $j$  and  $I_{b(j)}^{\text{max}}$  represents the maximum current limit of the branch  $j$ . The current's maximum limit is set at 1.2 times the branch's base current to prevent overloading.

### 2.2.2 Bus Voltage Constraint

The voltage at each bus should be kept within the permitted range given by;

$$V_n^{\min} \leq V_n \leq V_n^{\max} \quad (9)$$

Where  $V_n$  denotes the voltage of bus  $n$ ,  $V_n^{\min}$  and  $V_n^{\max}$  are the limits for the minimum and maximum voltages set at 0.9 p.u and 1.1 p.u, respectively. If the bus voltage violates these boundary conditions, the penalty factor of the objective function is applied.

### 2.2.3 DSTATCOM Reactive Power Constraint

The reactive power the DSTATCOM can inject into the network should also be within safe limits, as expressed below:

$$Q_{n_{\min}}^D \leq Q_n \leq Q_{n_{\max}}^D \quad (10)$$

Where  $Q_n$  is the DSTATCOM injected size at bus  $n$ ,  $Q_{n_{\min}}^D$  and  $Q_{n_{\max}}^D$  are respectively the minimum and maximum limits of the DSTATCOM reactive power and are set to 0MVar and 10MVar.

### 2.3 Total Cost Saving

In order to perform the cost-benefit analysis, the cost of the total energy loss before and after installing the DSTATCOM, the total annual cost, and the total cost saving are determined and compared to that of other techniques. Therefore, the total cost saving (TCS) is obtained by using Equation (11) [34].

$$TCS = K_e \sum_{i=1}^3 T_i P_i - \left( K_e \sum_{i=1}^3 T_i P_i^D + \sum_{i=1}^3 K_{ci} D_{cost} \right) \quad (11)$$

Where the first term on the right-hand side (RHS) is the energy loss cost before incorporating the DSTATCOM, the second and third terms are the energy loss cost when the DSTATCOM is incorporated and the DSTATCOM cost in a particular year, respectively.  $P_i$  and  $P_i^D$  are the power loss before and after DSTATCOM incorporation.

### 2.4 Simulation Parameters

The yearly total duration and the total power for each load level is presented in *Table 1*. The objective function variables (parameters of Equations (7) to (11)) used in the algorithm are defined in *Table 2* [14], [35].

**Table 1: Yearly Load duration and total load for the different load levels**

Load Level	Light Load	Medium Load	Peak Load
Time (hour/year)	2010	5240	1510
Total Load (kVAr)	3715 +j2300	4829.5 +j2300	5944+j2300

**Table 2: Setting of the Objective Function parameters**

$D_{cost_i}$ (\$/kVAr)	$n_D$ (years)	$r$ (%)	$K_e$ (\$/kWh)	$K_{ci}$			$\lambda$	$\mu$
				Light	Medium	Peak		
40	30	10	0.06	0.22831	0.60046	0.17123	2	1

## 3. SYSTEM MODELLING

The proposed approach has been tested on the conventional IEEE 33-bus system to demonstrate its effectiveness and performance. There are 33 buses and 32 branches in the IEEE-33 bus RDN. The base power and voltage for this system are 100 MVA and 12.66kV, and *Table 1* shows the total real and reactive power for the three load levels. The IEEE 33-bus RDN line data (line resistance and reactance) and the bus data (active and reactive loads) used in this study are shown in Appendix A and were taken from [36]. The electric power feeder from a generation/transmission network is designated bus number 1 in this system. The remaining buses are considered DSTATCOM candidate locations. *Figure 1* depicts the IEEE 33-bus network as a single line diagram [37], [38]. The size of the population is set at 50 particles and the intended termination criteria is 100 iterations. To perform distribution network load flow, compute actual and reactive power losses, and determine the appropriate position and size of DSTATCOM, the suggested technique was designed and implemented in the MATLAB environment.

The DSTATCOM and the RDN model as well as the backward sweep and forward sweep load flow technique used in this paper are detailed in the subsections below:

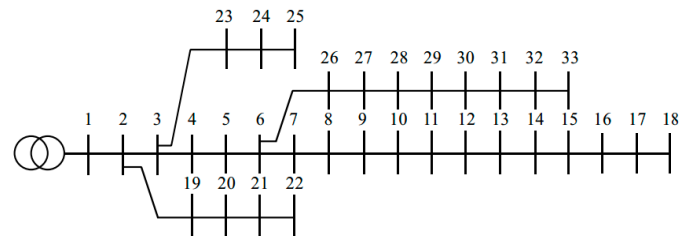

**Fig. 1: IEEE-33 bus single line diagram**

### 3.1 DSTATCOM and RDN Modelling

The DSTATCOM is a VSC (voltage source converter) that is usually shunt connected to inject or absorb active and reactive current through its PCC (point of common coupling). DSTATCOM is utilized exclusively for reactive power compensation in an IEEE 33 bus RDN in this study. Backward and forward sweep load flow computation is employed in this research. The steady-state mathematical model is presented in [14], [39]. *Figure 2* represents a section of two consecutive buses of the 33 bus RDN without the incorporation of the DSTATCOM while *Figure 3* is the current and voltage phasor diagrams of *Figure 2*. Also, *Figure 4* illustrates a section of two consecutive buses of the 33 bus RDN with the DSTATCOM incorporated while *Figure 5* depicts the current and voltage phasor diagrams of *Figure 4*.

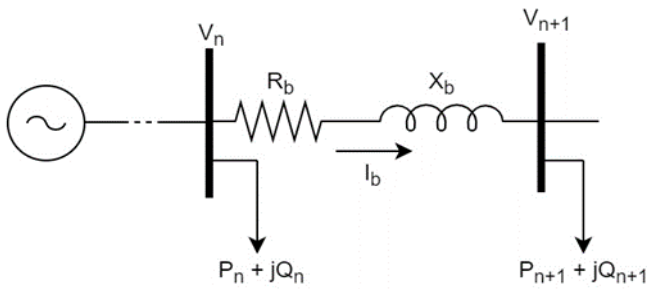

**Fig. 2:** Single line diagram of two successive buses of IEEE 33 bus network

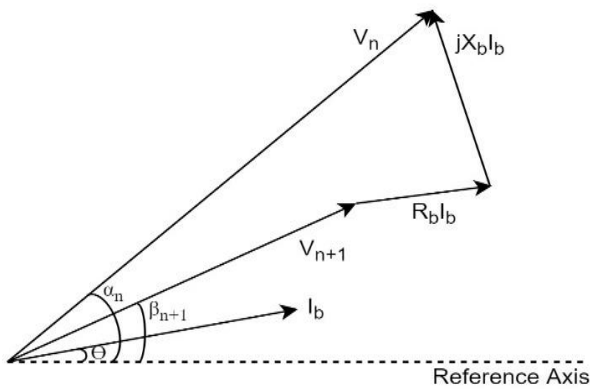
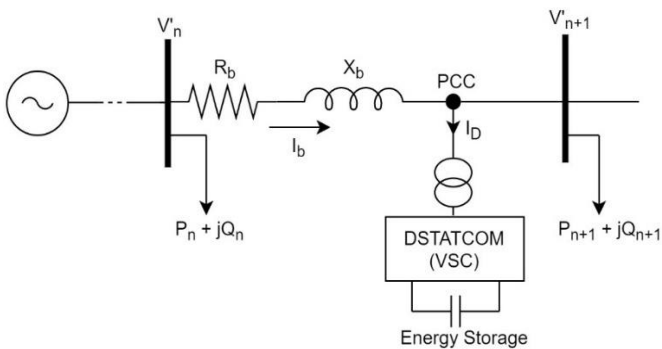

**Fig. 3:** Current and Voltage phasor diagram of two successive buses of IEEE 33 bus network

By applying Kirchhoff's voltage law (KVL) in *Figure 2*, the following equation is obtained;

$$V_{n+1} \angle \beta_{n+1} = V_n \angle \alpha_n - (R_b + jX_b) I_b \angle \theta \quad (12)$$

where  $n$  and  $n+1$  are the sending and receiving buses, the impedance between bus  $n$  and  $n+1$  is  $R_b + jX_b$ , the load of bus  $n$  is  $P_n + jQ_n$  and that of bus  $n+1$  is  $P_{n+1} + jQ_{n+1}$ ,  $V_n$  and  $V_{n+1}$  are the voltages of bus  $n$  and  $n+1$  before DSTATCOM installation,  $I_b$  is the current flowing through impedance  $R_b + jX_b$ ,  $\theta$  is the angle of  $I_b$ ,  $\alpha_n$  is the angle of  $V_n$ , and  $\beta_{n+1}$  is the angle of  $V_{n+1}$ .



**Fig. 4:** Single line diagram of two consecutive IEEE 33 buses with DSTATCOM

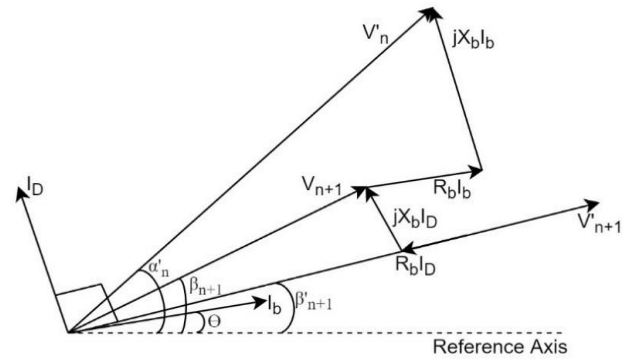

**Fig. 5:** Current and Voltage phasor diagram of two consecutive IEEE 33 buses with DSTATCOM

Performing KVL in *Figure 4* results in Equation (13) and the angle of DSTATCOM current in Equation(14).

$$V_{n+1}' \angle \beta'_{n+1} = V_n' \angle \alpha'_n - (R_b + jX_b) (I_b \angle \theta + I_D \angle (90^\circ + \beta'_{n+1})) \quad (13)$$

$$\angle I_D = 90^\circ + \beta'_{n+1} \quad (14)$$

Where,  $V_n'$  and  $V_{n+1}'$  are the voltages of bus  $n$  and  $n+1$  after DSTATCOM installation,  $I_D$  is the DSTATCOM current,  $\alpha'_n$  is the angle of  $V_n'$ ,  $\beta'_{n+1}$  is the angle of  $V_{n+1}'$ .

If the real and the imaginary parts of Equation (13) are separated, Equations (15) and (16) are obtained as;

*Real Part:*

$$I_D \cos(90^\circ + \beta'_{n+1}) = \left( \frac{V_n' R_b \cos \alpha'_n + V_n' X_b \sin \alpha'_n}{R_b^2 + X_b^2} + \frac{V_n' R_b \cos \beta'_{n+1}}{R_b^2 + X_b^2} - \frac{V_{n+1}' R_b \cos \beta'_{n+1}}{R_b^2 + X_b^2} - \frac{V_{n+1}' X_b \sin \beta'_{n+1}}{R_b^2 + X_b^2} - I_b \cos \theta \right) \quad (15)$$

*Imaginary Part:*

$$j(I_D \sin(90^\circ + \beta'_{n+1})) = \left( \frac{V_n' R_b \sin \alpha'_n + V_n' X_b \cos \alpha'_n}{R_b^2 + X_b^2} + \frac{V_n' X_b \cos \alpha'_n}{R_b^2 + X_b^2} - \frac{V_{n+1}' R_b \sin \beta'_{n+1}}{R_b^2 + X_b^2} - \frac{V_{n+1}' X_b \cos \beta'_{n+1}}{R_b^2 + X_b^2} - I_b \sin \theta \right) \quad (16)$$

For simplification purpose, let;

$$A = (ac - bd)^2 + (ad + bc)^2, B = 2(ac - bd)(V_{n+1}')(-R_b),$$

$$C = (V_{n+1}' \times R)^2 - (ad + bc), \text{ and } x = \sin \beta'_{n+1}$$

Where

$$a = \text{Real}(\bar{V}_n) - \text{Real}((R_b + jX_b)\bar{I}_b), b = \text{Imaginary}(\bar{V}_n) - \text{Real}((R_b + jX_b)\bar{I}_b)$$

$$, c = -X_b, d = -R_b$$

From Equations (15) and (16),  $\sin \beta'_{n+1}$  (i.e.  $x$ ) has two roots and hence both the values are computed for  $\bar{I}_D$ . However, in order to obtain the correct root, the boundary conditions in equation (17) are applied.

$$V'_{n+1} = V_{n+1} \Rightarrow \begin{cases} I_D=0 \\ \beta'_{n+1}=\beta_{n+1} \end{cases} \quad (18)$$

Applying these boundaries in Equations (15) and (16), the angle of the DSTATCOM current ( $\angle I_D$ ) can be obtained as:

$$\angle I_D = 90^\circ + \beta'_{n+1} = 90^\circ + \sin^{-1} x \quad (19)$$

And the DSTATCOM's current magnitude can also be determined from Equations (15) and (16) as shown in Equation(20).

$$I_D = \frac{V'_{n+1} \cos \beta'_{n+1} - a}{-d \sin \beta'_{n+1} - c \cos \beta'_{n+1}} \quad (20)$$

$$\bar{I}_D = I_D \angle I_D = I_D \angle (90^\circ + \beta'_{n+1}) \quad (21)$$

Therefore, the DSTATCOM's current vector (magnitude and angle) is computed by utilizing Equations (19) and (20) as presented in Equation(21).  $\bar{I}_D$  is the DSTATCOM current that must be injected at the required node of the IEEE 33 bus in order to compensate for reactive power and decrease power loss. As a result, the reactive power that the DSTATCOM can inject into the 33 bus network at PCC is expressed in Equation(22);

$$jQ_D = (V'_{n+1} \angle \beta'_{n+1}) (I_D \angle (90^\circ + \beta'_{n+1}))^* \quad (22)$$

Where \* is the complex conjugate and  $Q_D$  is the reactive power the DSTATCOM can inject.

### 3.2 Forward/Backward Sweep Load Flow and DSTATCOM Incorporation

To analyze the load flow in a distribution network considering DSTATCOM with any number of iterations in the forward sweep, the compensated node voltage magnitude can be presumed to be any value [40]. A choice of 1pu initial node voltage magnitude is used in this study. The compensated node's phase angle, reactive power, and DSTATCOM's size may now be computed using the aforementioned Equation(22). DSTATCOM's injected reactive power and updated voltage are utilized to continue forward sweep and determine the load currents throughout the following backward sweep load flow. This step is continued until the load flow converges [14], [39], [41], [42].

#### 3.2.1 Backward Sweep

The load current in each of the 33 buses understudy is determined in this stage as in Equation (24) and the branch current as in Equation(25).

$$\bar{S}_n = \bar{V}_n \bar{I}_{Ld}^* \quad (23)$$

$$\bar{I}_{Ld} = \frac{P_{Ld_n} - jQ_{Ld_n}}{\bar{V}_n^*} \quad (24)$$

$$\bar{I}_{b,n+1} = \bar{I}_{Ld_{n+1}} + \sum_{n=1}^m \bar{I}_{Ld_n} \quad (25)$$

Where  $P_{Ld_n}$  and  $Q_{Ld_n}$  are the load demand (active and reactive power) at the  $n^{\text{th}}$  bus,  $n = \text{bus number } (1, 2, \dots, m)$ ,  $S_n$  and  $I_{Ld}$  are the apparent power and load current, respectively.

To integrate the DSTATCOM at a particular bus,  $n+1$  bus, the requirement for reactive power at that bus is represented as:

$$Q_{Ld_{n+1}}^{\text{new}} = Q_{Ld_{n+1}} - Q_{D_{n+1}} \quad (26)$$

Where  $Q_{Ld_{n+1}}^{\text{new}}$  is the reactive power requirement at bus  $n+1$  and  $Q_{D_{n+1}}$  is the DSTATCOM reactive power from Equation(22).

#### 3.2.2 Forward Sweep

Following the completion of backward sweep load flow, the forward sweep algorithm is utilized to calculate the voltages at each of the 33 buses as in Equation(27).

$$\bar{V}_{n+1} = \bar{V}_n - \bar{I}_{b,n+1} (R_b + jX_b)_{n+1} \quad (27)$$

A convergence criterion is executed after the completion of backward/forward sweep in order to determine the voltage mismatch at each bus as illustrated in Equation (28) and(29).

$$\Delta V_n^{\text{nit}} = \left| \text{abs}(V_n^{\text{nit}}) - \text{abs}(V_n^{\text{nit}-1}) \right| \quad (28)$$

$$\text{For } \Delta V_n^{\text{nit}} < \text{accuracy} \quad (29)$$

Where  $\text{nit}$  the number of iteration is,  $\Delta V_n^{\text{nit}}$  is the voltage mismatch, and the accuracy is taken to be  $10e^{-5}$ . The forward and backward sweep process is made repetitive until the convergence criterion is met.

## 4. PROPOSED HYBRID IMMUNE AND GENETIC ALGORITHM

J. Holland discovered GA in the 1960s, and Goldberg further described it [43]. GA is a random global search strategy that addresses problems by mimicking natural evolutionary processes [44]. When it comes to finding good solutions to optimization problems, genetic algorithm is a popular alternative. GA has been applied successfully to a number of complex optimization problems on the process demonstrating its superiority to conventional optimization approaches, particularly whenever the system under consideration has several local optimum solutions. GA has the ability to avoid

being trapped at local optimal solution and can evaluate candidates based on fitness score. However, GA computation is slow, has computational complexity and does not explore all the solution space of the problem.

On the other hand, AI is a collection of computational systems that are focused on theoretical immunology, theories and mechanisms, observed immune functions, and have been used to solve a variety of complex optimization problems [45]. The immune systems' goals are to shield the body against diseases caused by agents (pathogens) as well as to destroy abnormal cells [45]. IA is fast, has less computational complexity, and can explore all solution space of the problem. However, IA can be terminated at local optimal values hence resulting to premature convergence. Details of the use of IA and GA for solving optimization problems in power system are described in [14] and [46] respectively.

The proposed hybrid method was simulated using the MATLAB environment for the problem formulated in Section 2. IA and GA were hybridized in this research to complement each other's strengths and weaknesses stated above. IA operators were employed to determine the size of the DSTATCOM and GA operators used to ensure fitness of the computed DSTATCOM size. Using Equations (23) to(29), a base case load flow was performed using backward forward sweep and the proposed method. The active power loss, as well as the bus and voltages before and after DSTATCOM insertion, were noted.

After a successful backward forward sweep load flow was carried out, the DSTATCOM was placed into various buses and the size was determined by the algorithm by utilizing Equations (13), (20), (21), and (22). The DSTATCOM is incorporated into various buses (except bus1) of the 33 buses and in each case sized by the algorithm using different iterations to determine the optimal location and size. The process continues for all the buses until a convergence criterion of the iteration is met. This was achieved by utilizing Equations (28) and(29). A detailed step by step procedure of the proposed IA-GA is highlighted below:

*Step1:* Read data from the IEEE-33 bus test system. This includes active and reactive power, line resistance and line reactance.

*Step 2:* Perform load flow analysis for the base case (load flow analysis before placement and sizing of the DSTATCOM).

*Step 3:* Definition of parameters (define number of buses, bus data, and all GA and IA parameters i.e., number of populations, number of clones, number of tours, maximum age, mutation rate, maximum iterations, and number of functions to be evaluated).

*Step 4:* Initialization. Initialize the DSTATCOM position and size, cost function, population and age, number of decisions.

*Step 5:* Evaluation of the cost based on Equation (3), objective function (Equation(7)), and position.

*Step 6:* Apply IA to calculate the size of the DSTATCOM by using mutation, tournament, ageing operators.

*Step 7:* Apply GA to determine the fitness of the Var size in accordance with the objective function in Equation (7) using GA operators such as selection, crossover, and mutation).

*Step 8:* Attainment of the maximum number of iterations. If maximum iteration is attained, then a load flow analysis is performed with the DSTATCOM placed otherwise the process starts again from step 5 and continues until the highest number of iterations is attained.

*Step 9:* Steps 4 to 8 are repeated for all the number of buses with the exception of bus one.

*Step 10:* Search for the best solution for all the allocations.

*Step 11:* Print results for optimal bus number, optimal DSTATCOM size for all the three load conditions, power loss for all the three load conditions, and voltages for each bus for all the three load conditions and stop the search.

## 5. RESULTS AND DISCUSSION

This section presents and discusses the simulation results for optimal DSTATCOM position and size, power loss reduction, and enhancement of voltage profile. Cost-benefit analysis and evaluation of the results obtained are also presented.

### 5.1 DSTATCOM Allocation and Voltage Profile

Table 3 shows the results for optimal bus number, DSTATCOM optimal size as well as the yearly cost of the optimally allocated DSTATCOM. The optimal location of the DSTATCOM was found to be at bus seven (7) of the IEEE-33 bus RDN for all three load levels. This uniformity in the DSTATCOM siting outcome for the three load levels was a result of the uniform increase in the medium and peak load levels by a factor of 1.3 and 1.6 of the light load level, as illustrated in Table 1. The optimal size of the DSTATCOM shows a steady increase as the load level increases from light, medium to peak. The optimal DSTATCOM sizes for the light, medium, and peak load levels were obtained as 1456.65kVAr, 1523.61kVAr, and 2005.36kVAr, respectively. Also, the annual cost of DSTATCOM was obtained to be \$5408.20 for light load condition, \$5656.83 for Medium load condition, and \$7445.45 for peak load condition

**Table 3: Results for optimal bus number, DSTATCOM size and the yearly cost**

Load Level	Light	Medium	Peak
Bus Number	7		
DSTATCOM Capacity (kVAr)	1456.65	1523.61	2005.36
Yearly Cost of DSTATCOM (\$)	5408.20	5656.83	7445.45

Figure 7 illustrates the power loss before and after DSTATCOM allocation for the three different load levels under study. B. Com means before compensation (i.e. before installing the DSTATCOM) and A. Com means after compensation (i.e. after DSTATCOM installation). For the light load condition, the power loss before compensation is

202.665kW while after the incorporation of the DSTATCOM, the power loss was drastically reduced to 156.9488kW. This indicates a 22.56% reduction in power loss as a result of the DSTATCOM optimal allocation.

In the medium load scenario, the power loss before DSTATCOM incorporation was 305.8144kW and then reduces to 254.6037kW after incorporating the DSTATCOM. The optimal installation of the DSTATCOM creates a 16.75% power loss reduction impact.

During peak load condition, the power loss was 442.3904kW before compensation and 382.9452kW after compensation. This indicates a 13.44% reduction in power loss caused by the optimal DSTATCOM allocation.

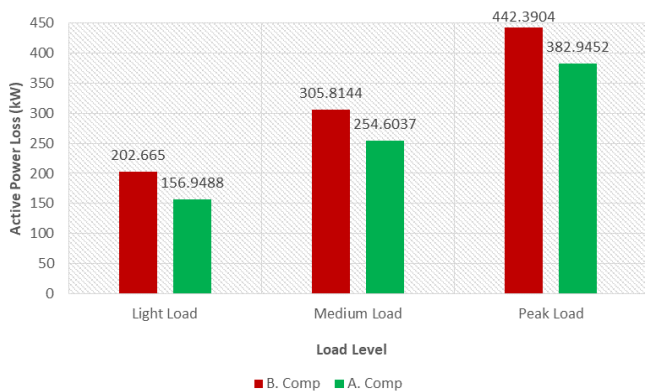

**Fig. 7:** Power Loss before and after DSTATCOM sizing and location

The voltage profiles for the three cases under study are illustrated in Figures 8, 9, and 10. For the light load condition, the voltage profile is shown in Figure 8. Without DSTATCOM integration to the RDN, the minimum voltage was at bus 18 at 0.9131 p.u and the average voltage for this load condition was observed to be 0.9485 p.u. Bus 18 is the farthest bus from the AC source in the IEEE-33 bus topology, and so has the largest potential for voltage drop. When the DSTATCOM is optimally sized and connected to bus 7, the voltage profile was greatly enhanced across all buses as evidently seen in Figure 8. The voltage rises from 0.9131 p.u to 0.9335 p.u in bus 18, while the system's average voltage was 0.9604 p.u.

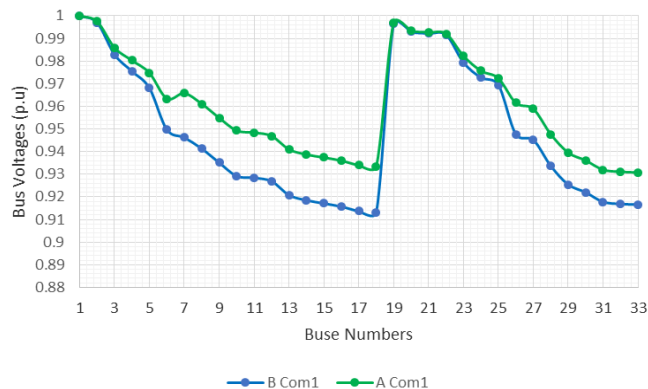

**Fig. 11:** Voltage Profile for combined Light, Medium, and Peak Load Conditions

### 5.2 Cost-Benefit Analysis

Using Equation (11) and the results of Table 3 and Figure 7, the cost of installing DSTATCOM and the financial benefit of its installation is acquired and illustrated in Table 4. The results show financial benefits for installing the DSTATCOM at the light and medium load conditions and that it is most economical to install one DSTATCOM during medium load condition. However, installing one DSTATCOM at peak load condition does not yield financial benefits. An annual total cost saving of \$8582.96 is made each year for up to the 30years life span of the DSTATCOM.

**Table 4:** Cost and financial benefit of DSTATCOM installation

Specifics	Light	Medium	Peak	Total
Energy loss cost before DSTATCOM (\$)	24320.40	96517.55	39816.26	160654.21
Energy loss cost after DSTATCOM (\$)	18795.61	80300.60	34464.56	133560.77
Yearly cost of DSTATCOM (\$)	5408.20	5656.83	7445.45	18510.48
Annual total cost saving (\$)	116.59	10560.12	-2093.75	<b>8582.96</b>

### 5.3 Comparisons and Performance Evaluation

Table 5 presents a comprehensive and succinct comparison of DSTATCOM optimal location and size, power loss reduction before and after DSTATCOM optimal placement, and average voltage profile improvement before and after compensation. This was achieved by using the findings of this research and that of the existing methods in an IEEE-33 bus RDN. The proposed approach reduces the power loss by 22.558% for light load condition, 16.746% for medium load condition, and 13.437% for the peak load condition which is higher than the percentage power loss reduction of IA and PSO. Also, the average voltage profile was improved in the proposed method by 1.239%, 1.327%, and 1.775% for light, medium, and peak load conditions respectively as opposed to an average voltage profile improvement of 1.157%, 1.254%, and 1.618% for light, medium, and peak load conditions respectively for IA method. It is apparent from the findings that the proposed technique performs better than IA and PSO in reducing power loss and enhancing the voltage profile.

**Table 5:** Comparison of Performance between the proposed method and previous approaches



Specifics	IA[14]			PSO[47]	Proposed Method		
	Light	Medium	Peak	Light	Light	Medium	Peak
Optimal Location	12	12	12	28 and 9	7	7	7
Optimal Size (kVar)	962.49	1008.00	1222.66	1508.201190.90	1456.65	1523.61	2005.36
Base Case Power Loss (kW)	202.680	305.860	442.410	193.927	202.67	305.814	442.390
Power Loss Reduction (kW)	171.810	272.040	407.710	160.270	156.949	254.604	382.945
% Power Loss Reduction	17.968%	12.432%	8.511%	21.00%	22.558%	16.746%	13.437%
Average Voltage B. Comp (p.u)	0.9485	0.9367	0.9244	-	0.9485	0.9367	0.9244
Average Voltage A. Comp (p.u)	0.9596	0.9486	0.9396	-	0.9604	0.9493	0.9411
% Average Voltage Improvement	1.157%	1.254%	1.618%	-	1.239%	1.327%	1.775%

## 6. CONCLUSION

A novel method based on a hybrid IA-GA for optimal DSTATCOM sizing and placement with the aim of reducing power loss and enhancing the voltage profile of RDN has been presented. The suggested approach was evaluated with three distinct load levels (light, medium, and peak loads) on an IEEE 33-bus RDN. The optimal allocation of DSTATCOM in a radial distribution system utilizing the proposed hybrid IA-GA considerably decreases the total power loss and enhances the voltage profile, according to the simulation results. The simulation results further demonstrate that when compared to existing approaches, the proposed method produces better outcomes. Considering the exorbitant price of FACTS devices, a cost-benefit analysis was provided and results showed a huge overall annual cost saving when the DSTATCOM was installed. Further studies could consider the use of two or more DSTATCOM devices, especially at peak load condition.

## AUTHOR CONTRIBUTIONS

Mohamed Amidu Kallon: Conceived, designed, and perform the experiment; simulate the model, analyze the data; and wrote the paper.

Prof. George Nyauma Nyakoe: Analyse the data, results, and edit the paper.

Prof. Christopher Maina Muriithi: Analyse the data, results, and edit the paper.

## ACKNOWLEDGMENTS

The authors greatly acknowledge the African Union Commission through the Pan African University Institute for Basic Sciences, Technology and Innovation (PAUSTI) for funding this research.

## CONFLICTS OF INTEREST

None.

## REFERENCES

- [1] A. Hinda, M. Khiat, and Z. Boudjema, 'Advanced control scheme of a unified power flow controller using sliding mode control', *Int. J. Power Electron. Drive Syst.*, vol. 11, no. 2, pp. 625–633, 2020, doi: 10.11591/ijpeds.v11.i2.pp625-633.
- [2] D. S. Veeraganti, V. Pujari, V. G. Kumar, R. Nittala, and E. Soumya, 'DSTATCOM optimum position and sizing in a distribution system using various approaches', *Proteus J.*, vol. 11, no. 11, pp. 233–241, 2021.
- [3] S. Nagaballi and V. S. Kale, 'A metaphor-less based AI technique for optimal deployment of DG and DSTATCOM considering reconfiguration in the RDS for Techno-Economic benefits', *J. Intell. Fuzzy Syst.*, vol. 4, no. 3, pp. 1–11, Apr. 2021, doi: 10.3233/JIFS-189891.
- [4] C. M. Castiblanco-Pérez, D. E. Toro-Rodríguez, O. D. Montoya, and D. A. Giral-Ramírez, 'Optimal Placement and Sizing of D-STATCOM in Radial and Meshed Distribution Networks Using a Discrete-Continuous Version of the Genetic Algorithm', *Electron.* 2021, Vol. 10, Page 1452, vol. 10, no. 12, p. 1452, Jun. 2021, doi: 10.3390/ELECTRONICS10121452.
- [5] A. F. A. Kadir, A. Mohamed, H. Shareef, and M. Z. C. Wanik, 'Optimal placement and sizing of distributed generations in distribution systems for minimizing losses and THD<sub>v</sub> using evolutionary programming', *Turkish J. Electr. Eng. Comput. Sci.*, vol. 21, no. Sup.2, pp. 2269–2282, Nov. 2013.
- [6] T. Yuvaraj, K. R. Devabalaji, and K. Ravi, 'Optimal Placement and Sizing of DSTATCOM Using Harmony Search Algorithm', in *Energy Procedia*, Nov. 2015, vol. 79, pp. 759–765, doi: 10.1016/j.egypro.2015.11.563.
- [7] S. Davarzani, I. Pisica, G. A. Taylor, and K. J. Munisami, 'Residential Demand Response Strategies and Applications in Active Distribution Network Management', *Renew. Sustain. Energy Rev.*, vol. 138, p. 110567, Mar. 2021, doi: 10.1016/J.RSER.2020.110567.
- [8] M. A. Kallon, G. N. Nyakoe, and C. M. Muriithi, 'DSTATCOM Application for Distribution Network Power Quality Enhancement: A Review', in 2021 IEEE PES/IAS PowerAfrica, Sep. 2021, pp. 1–5, doi: 10.1109/POWERAFRICA52236.2021.9543214.
- [9] A. M. Stanisavljević, V. A. Katić, B. P. Dumnić, and B. P. Popadić, 'Overview of voltage dips detection analysis methods', in 19th International Symposium on Power Electronics, IEEE 2017, Dec. 2017, vol. 2017-Decem, pp. 1–6, doi: 10.1109/PEE.2017.8171703.
- [10] N. Aguiar, A. Dubey, and V. Gupta, 'Network-Constrained Stackelberg Game for Pricing Demand Flexibility in Power Distribution Systems', *IEEE Trans. Smart Grid*, vol. 12, no. 5,

- pp. 4049–4058, Sep. 2021, doi: 10.1109/TSG.2021.3078905.
- [11] D. Kumar and P. A. Dubey, 'Literature Survey on Power Quality and Voltage Flicker Reduction using D-STATCOM', *Int. J. Sci. Res. Eng. Trends*, vol. 7, no. 1, pp. 452–456, 2021.
- [12] A. A. Shehata, A. Refaat, and N. V. Korovkin, 'Optimal Allocation of FACTS Devices based on Multi-Objective Multi-Verse Optimizer Algorithm for Multi-Objective Power System Optimization Problems', in *2020 International Multi-Conference on Industrial Engineering and Modern Technologies, FarEastCon 2020*, Oct. 2020, pp. 1–7, doi: 10.1109/FAEASTCON50210.2020.9271359.
- [13] A. A. Shehata, A. Refaat, M. K. Ahmed, and N. V. Korovkin, 'Optimal placement and sizing of FACTS devices based on Autonomous Groups Particle Swarm Optimization technique', *Arch. Electr. Eng.*, vol. Vol. 70, no. nr 1, pp. 161–172, 2021, doi: 10.24425/AEE.2021.136059.
- [14] S. A. Taher and S. A. Afsari, 'Optimal location and sizing of DSTATCOM in distribution systems by immune algorithm', *Int. J. Electr. Power Energy Syst.*, vol. 60, pp. 34–44, Sep. 2014, doi: 10.1016/j.ijepes.2014.02.020.
- [15] V. Tejaswini and D. Susitra, 'Optimal Location and Compensation Using D-STATCOM: A Hybrid Hunting Algorithm', *J. Control. Autom. Electr. Syst.* 2021 324, vol. 32, no. 4, pp. 1002–1023, May 2021, doi: 10.1007/S40313-021-00724-X.
- [16] B. Khan, K. Redae, E. Gidey, O. P. Mahela, I. B. M. Taha, and M. G. Hussien, 'Optimal integration of DSTATCOM using improved bacterial search algorithm for distribution network optimization', *Alexandria Eng. J.*, Nov. 2021, doi: 10.1016/J.AEJ.2021.11.012.
- [17] M. Mohammadi, M. Abasi, and A. M. Rozbahani, 'Fuzzy-GA based algorithm for optimal placement and sizing of distribution static compensator (DSTATCOM) for loss reduction of distribution network considering reconfiguration', *J. Cent. South Univ.*, vol. 24, no. 2, pp. 245–258, Feb. 2017, doi: 10.1007/s11771-017-3425-9.
- [18] D. K. Rukmani et al., 'A New Approach to Optimal Location and Sizing of DSTATCOM in Radial Distribution Networks Using Bio-Inspired Cuckoo Search Algorithm', *Energies* 2020, Vol. 13, Page 4615, vol. 13, no. 18, p. 4615, Sep. 2020, doi: 10.3390/EN13184615.
- [19] S. Devi and M. Geethanjali, 'Optimal location and sizing of Distribution Static Synchronous Series Compensator using Particle Swarm Optimization', *Int. J. Electr. Power Energy Syst.*, vol. 62, pp. 646–653, Nov. 2014, doi: 10.1016/j.ijepes.2014.05.021.
- [20] M. O. Okelola, S. Adeleke Salimon, O. A. Adegbola, E. Idowu Ogunwole, S. O. Ayanlade, and B. Abiodun Aderemi, 'Optimal Siting and Sizing of D-STATCOM in Distribution System using New Voltage Stability Index and Bat Algorithm', *2021 Int. Congr. Adv. Technol. Eng. ICOTEN 2021*, Jul. 2021, doi: 10.1109/ICOTEN52080.2021.9493461.
- [21] K. R. S. S. Prasad, T. Neeraja, and Y. Pavani, 'Optimal Placement of DSTATCOM for Power Loss Reduction and Voltage Profile Improvement in Radial Distribution Systems', *Int. J. Adv. Sci. Technol.*, vol. 29, no. 4, pp. 840–847, 2020.
- [22] S. Saralaya and K. Manjunatha Sharma, 'Optimal Sizing, Placement and Performance Analysis of DSTATCOM with Improved Controller without Current Sensors', *4th Int. Symp. Devices, Circuits Syst. ISDCS 2021 - Conf. Proc.*, Mar. 2021, doi: 10.1109/ISDCS52006.2021.9397892.
- [23] M. N. Abdrabo, A. Y. Hetata, S. S. Kaddah, and M. I. Elsaid, 'Optimal Allocation of Multiple D-STATCOM in Distribution System Using PSO. (Dept. E)', *MEJ. Mansoura Eng. J.*, vol. 44, no. 2, pp. 10–18, Jun. 2020, doi: 10.21608/BFEMU.2020.95020.
- [24] N. Kanwar, N. Gupta, K. R. Niazi, and A. Swarnkar, 'Improved Cat Swarm Optimization for Simultaneous Allocation of DSTATCOM and DGs in Distribution Systems', *J. Renew. Energy*, vol. 2015, pp. 1–10, 2015, doi: 10.1155/2015/189080.
- [25] S. K. Dash and S. Mishra, 'Simultaneous Optimal Placement and Sizing of D-STATCOMs Using a Modified Sine Cosine Algorithm', *Lect. Notes Networks Syst.*, vol. 202 LNNS, pp. 423–436, 2021, doi: 10.1007/978-981-16-0695-3\_41.
- [26] B. H. Tolabi, M. H. Ali, and M. Rizwan, 'Simultaneous reconfiguration, optimal placement of DSTATCOM, and photovoltaic array in a distribution system based on fuzzy-aco approach', *IEEE Trans. Sustain. Energy*, vol. 6, no. 1, pp. 210–218, Jan. 2015, doi: 10.1109/TSSTE.2014.2364230.
- [27] A. Abdulrazzak Jasim, H. J. Kareem, A. A. Jasim, H. J. Kareem, N. Ali, and H. Al-Zubaydi, 'D-STATCOM Allocation for Stabilization of Voltage in Multimachine Power System Using HBF-GWO', *J. Green Eng.*, vol. 10, no. 10, pp. 7360–7377, 2020.
- [28] D. Das, 'Optimal placement of capacitors in radial distribution system using a Fuzzy-GA method', *Int. J. Electr. Power Energy Syst.*, vol. 30, no. 6–7, pp. 361–367, Jul. 2008, doi: 10.1016/j.ijepes.2007.08.004.
- [29] I. C. da Silva, S. Carneiro, E. J. de Oliveira, J. de Souza Costa, J. L. Rezende Pereira, and P. A. N. Garcia, 'A heuristic constructive algorithm for capacitor placement on distribution systems', *IEEE Trans. Power Syst.*, vol. 23, no. 4, pp. 1619–1626, 2008, doi: 10.1109/TPWRS.2008.2004742.
- [30] E. Lakervi and E. J. Holmes, *Electricity Distribution Network Design*. Institution of Engineering and Technology, 2003.
- [31] E. Naderi, H. Seifi, and M. S. Sepasian, 'A dynamic approach for distribution system planning considering distributed generation', *IEEE Trans. Power Deliv.*, vol. 27, no. 3, pp. 1313–1322, 2012, doi: 10.1109/TPWRD.2012.2194744.
- [32] M. Ramalinga Raju, K. V. S. Ramachandra Murthy, and K. Ravindra, 'Direct search algorithm for capacitive compensation in radial distribution systems', *Int. J. Electr. Power Energy Syst.*, vol. 42, no. 1, pp. 24–30, Nov. 2012, doi: 10.1016/J.IJEPES.2012.03.006.
- [33] S. Sundhararajan and A. Pahwa, 'Optimal Selection of Capacitors for Radial Distribution Systems using A Genetic Algorithm', *IEEE Trans. Power Syst.*, vol. 9, no. 3, pp. 1499–1507, 1994, doi: 10.1109/59.336111.
- [34] M. H. Moradi, A. Zeinalzadeh, Y. Mohammadi, and M. Abedini, 'An efficient hybrid method for solving the optimal sitting and sizing problem of DG and shunt capacitor banks simultaneously based on imperialist competitive algorithm and genetic algorithm', *Int. J. Electr. Power Energy Syst.*, vol. 54, pp. 101–111, Jan. 2014, doi: 10.1016/J.IJEPES.2013.06.023.
- [35] K. D. R. Vijayakumar K, 'A new method for optimal location of

- FACTS controllers using genetic algorithm.', *J Theor Appl Inf. Technol.*, vol. 3, no. 4, pp. 1–6, 2007.
- [36] M. M'dioud, R. Bannari, and I. Elkafazi, 'Reconfiguration of the Radial Distribution for Multiple DGs by Using an Improved PSO', *Networking, Intell. Syst. Secur.*, vol. 237, pp. 257–273, 2021, doi: 10.1007/978-981-16-3637-0\_18.
- [37] C. Barbulescu, S. Kilyeni, C. Oros, A. Bittenbinder, and M. Salinschi, 'Heuristic and metaheuristic techniques based distribution network reconfiguration. Case study: IEEE 33 bus system', 2021 *Int. Conf. Appl. Theor. Electr. ICATE 2021 - Proc.*, May 2021, doi: 10.1109/ICATE49685.2021.9465030.
- [38] M. I. A. S. A. Vimal Katiyar, 'Design and analysis of 33-bus solar based MLDG distribution system', *Turkish J. Comput. Math. Educ.*, vol. 12, no. 6, pp. 4918–4931, Jun. 2021.
- [39] J. Sanam, 'Optimization of planning cost of radial distribution networks at different loads with the optimal placement of distribution STATCOM using differential evolution algorithm', *Soft Comput.*, vol. 24, no. 17, pp. 13269–13284, 2020, doi: 10.1007/s00500-020-04739-5.
- [40] S. Kawambwa, R. Mwifunyi, D. Mnyanghwal, N. Hamisi, E. Kalinga, and N. Mvungi, 'An improved backward/forward sweep power flow method based on network tree depth for radial distribution systems', *J. Electr. Syst. Inf. Technol.* 2021 81, vol. 8, no. 1, pp. 1–18, Mar. 2021, doi: 10.1186/S43067-021-00031-0.
- [41] R. Baghipour and S. M. Hosseini, 'Placement of DG and Capacitor for Loss Reduction, Reliability and Voltage Improvement in Distribution Networks Using BPSO', *Int. J. Intell. Syst. Appl.*, vol. 4, no. 12, pp. 57–64, Nov. 2012, doi: 10.5815/ijisa.2012.12.08.
- [42] M. E. Baran and F. F. Wu, 'Optimal capacitor placement on radial distribution systems', *IEEE Trans. Power Deliv.*, vol. 4, no. 1, pp. 725–734, 1989, doi: 10.1109/61.19265.
- [43] E. David Goldberg, 'Genetic Algorithms in Search Optimization & Machine Learning', Addison-Wesley, 1989.
- [44] M. A. Tolba, V. N. Tulsy, and A. A. Z. Diab, 'Optimal allocation and sizing of multiple distributed generators in distribution networks using a novel hybrid particle swarm optimization algorithm', in 2017 IEEE Russia Section Young Researchers in Electrical and Electronic Engineering Conference, ElConRus 2017, Apr. 2017, pp. 1606–1612, doi: 10.1109/EIConRus.2017.7910880.
- [45] L. N. de Castro and J. I. Timmis, 'Artificial immune systems as a novel soft computing paradigm', *Soft Comput.*, vol. 7, no. 8, pp. 526–544, Jul. 2003, doi: 10.1007/s00500-002-0237-z.
- [46] A. F. Ali and M. A. Tawhid, 'A hybrid particle swarm optimization and genetic algorithm with population partitioning for large scale optimization problems', *Ain Shams Eng. J.*, vol. 8, no. 2, pp. 191–206, 2017, doi: 10.1016/j.asej.2016.07.008.
- [47] M. Abdrabo, A. Hetata, S. Kaddah, and M. Elsaid, 'Optimal Allocation of Multiple D-STATCOM in Distribution System Using PSO', *Bull. Fac. Eng. Mansoura Univ.*, vol. 44, no. 2, pp. 10–18, 2020, doi: 10.21608/bfemu.2020.95020.
- [48] Rohan Sharma, Navin Kumar Paliwal (2013), Analysis of the effectiveness of DSTATCOM for Voltage Sag Reduction. *IJEER* 1(1), 20-24. DOI: 10.37391/IJEER.010101

© 2021 by the Mohamed Amidu Kallon, George Nyauma Nyakoe and Christopher Maina Muriithi. Submitted for possible open access publication under the terms and conditions of the Creative Commons Attribution (CC BY) license (<http://creativecommons.org/licenses/by/4.0/>).

